



Rock Anchor - Stainless Steel AISI 316L
Πλακέτα Ασφάλισης - Ανοξείδωτο Ατσάλι AISI 316L

user's manual / εγχειρίδιο χρήσης

certificates
πιστοποιήσεις

EN 959:2018
EN 795:2012
EN 365:2004

UIAA

suitable for
κατάλληλο για



Serial number (10th week of 2020)
Σειριακός Αριθμός (10^η εβδομάδα του 2020)

Material: 316L
Υλικό: 316L

Strenght / Φορτίο

International Climbing and Mountaineering Federation
Εθνική Ομοσπονδία Αναρρίχησης και Ορειβασίας

Model / Μοντέλο

Brand / Μάρκα

Class of the anchor: 2
Κλάση πλακέτας: 2

1P = Used by only one person at a time
1P = Χρησιμοποιείται από έναν άνθρωπο κάθε φορά

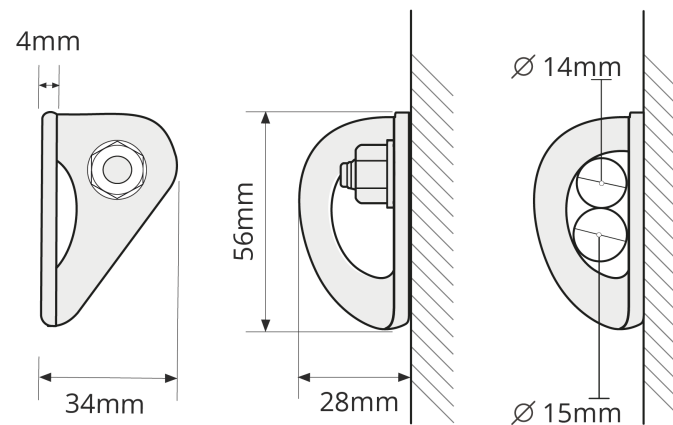

installation / τοποθέτηση

A

B

C

D

Wrench tool No 17
Torque = 30Nm

Κλειδί No 17
Ροπή = 30Nm

resistance requirements - statics tests
απαιτήσεις στατικής φόρτισης

A

EN 795:2012 12kN
EN 959:2018 15kN
UIAA 123 - 2 20kN

B

EN 795:2012 12kN
EN 959:2018 25kN
UIAA 123 - 2 25kN

effective strenght / μέγιστη φόρτιση

A >29kN **B** >30kN

dynamic tests - effective strenght
δυναμική φόρτιση

EN 795:2012

load direction	peak of force (kN)	Deflection of anchor device (mm)	Displacement of anchor point (mm)
A	9,0	9,0	8,0
B	9,2	4,0	2,0



APPROVED USE / ΟΡΘΗ ΧΡΗΣΗ

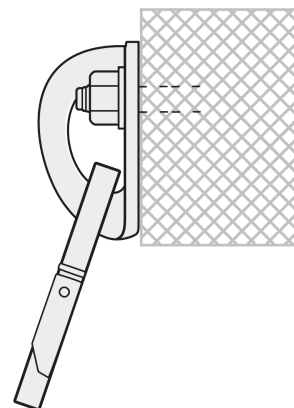
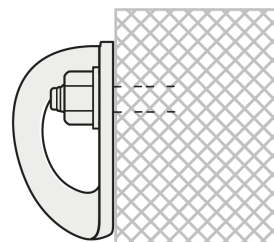
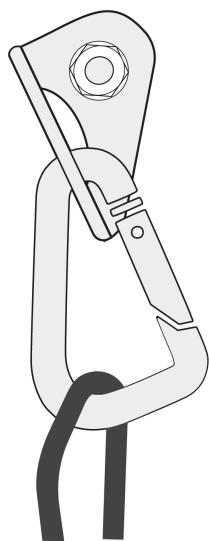
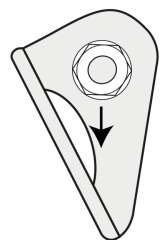

rock / βράχος
rope / σκοινί



WARNING : RISK OF ACCIDENT, INJURY OR DEATH

ΠΡΟΣΟΧΗ : ΚΙΝΔΥΝΟΣ ΑΤΥΧΗΜΑΤΟΣ, ΤΡΑΥΜΑΤΙΣΜΟΥ Ή ΘΑΝΑΤΟΥ

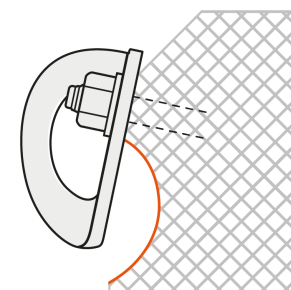
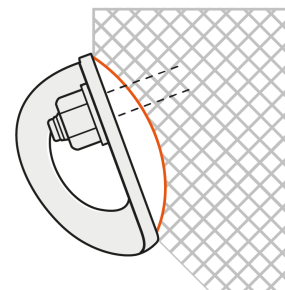
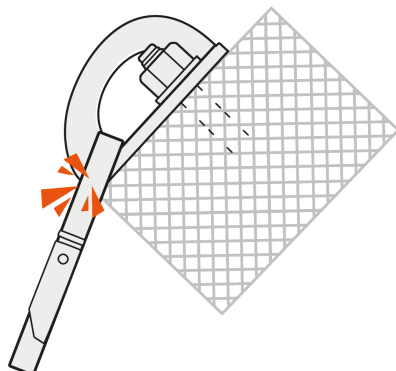
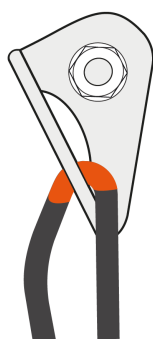
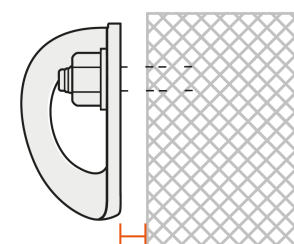
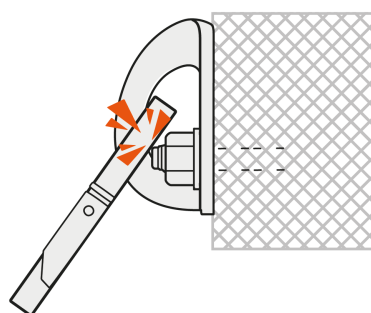
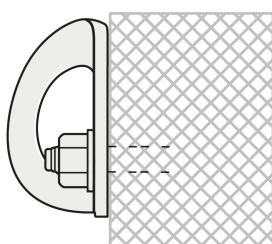
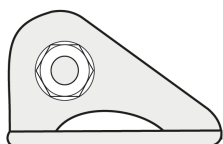

Use Sea Urchin and rock anchor only in case of compact rock (massif stone - granite). Don't use it on soft rock (sandstone e.t.c.)

Χρησιμοποιήστε το Sea Urchin και το βύσμα μόνο σε περίπτωση συμπαγή βράχου (αβεστούλιθου ή γρανίτη).
Μην τα χρησιμοποιείτε σε μαλακό βράχο (αμμόλιθου κτλ.)

lappas
climbing bolts

produced by climbers for climbers

LAPPAS S.A.

5Km Ioannina to Athens
Postal Code 45500
IOANNINA, GREECE

(+30) 6932 423 007

www.lappasclimbing.com

info@lappasclimbing.com

lappas climbing bolts