



D12 RHEA TITAN

Hanger - Titanium Gr2

Πλακέτα Ασφάλισης - Τιτάνιο Βαθμού 2

user's manual / εγχειρίδιο χρήσης

certificates ποιότητες EN 959:2018
 suitable for κατάλληλο για
 outdoor caving rope access canyoning
 UIAA 123_3

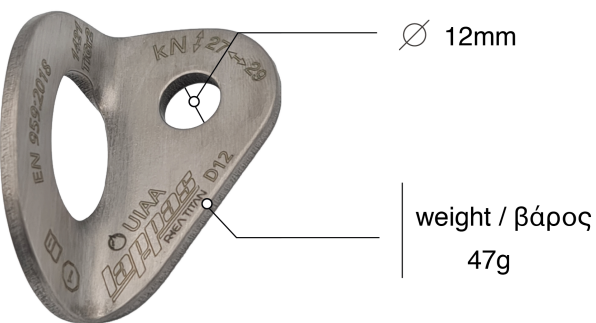

Serial Number (week/year) Σειριακός Αριθμός (εβδομάδα/έτος)
 Material: Ti Gr2 Υλικό: Τι Gr2
 Strength / Φορτίο
 Tested according to the standard indicated Ελεγμένο σύμφωνα με τα αναγραφόμενα πρότυπα
 International Climbing and Mountaineering Federation Διεθνής Ομοσπονδία Αναρρίχησης και Ορειβασίας
 Read instructions before use Διαβάστε τις οδηγίες πριν την χρήση
 Model / Μοντέλο
 Brand / Μάρκα
 Class of the anchor: 1 Κλάση πλακέτας: 1

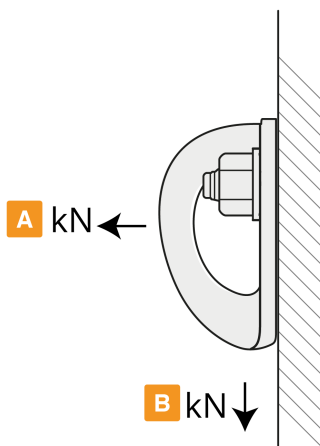
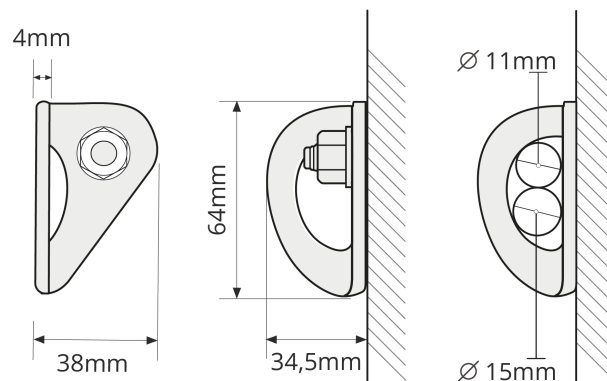

installation / τοποθέτηση

Wrench tool No 19 Torque = 50Nm
 Κλειδί No 19 Ροπή = 50Nm
 ∅ 12mm

resistance requirements - statics tests

απαιτήσεις στατικής φόρτισης

A	EN 959:2018	15kN
	UIAA 123_3	20kN
B	EN 959:2018	25kN
	UIAA 123_3	25kN

effective strength / μέγιστη φόρτιση

A	27,8kN	B	29kN
---	--------	---	------



APPROVED USE / ΟΡΘΗ ΧΡΗΣΗ

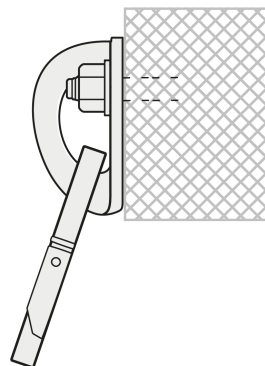
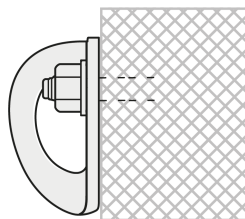
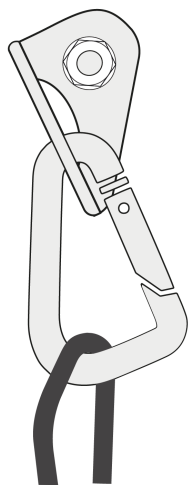
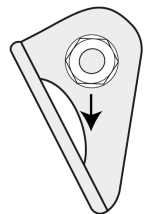

 rock / βράχος

 rope / σκοινί



WARNING : RISK OF ACCIDENT, INJURY OR DEATH

ΠΡΟΣΟΧΗ : ΚΙΝΔΥΝΟΣ ΑΤΥΧΗΜΑΤΟΣ, ΤΡΑΥΜΑΤΙΣΜΟΥ Ή ΘΑΝΑΤΟΥ

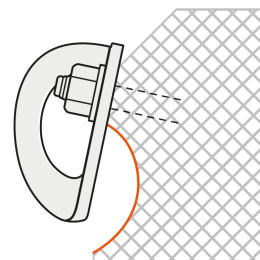
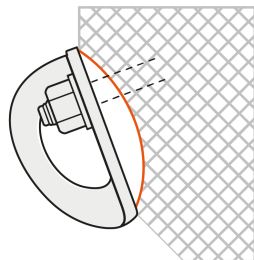
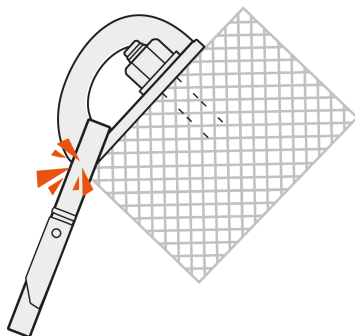
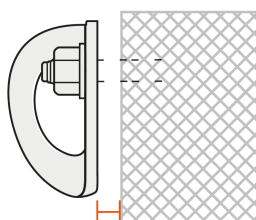
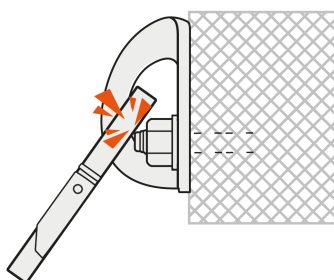
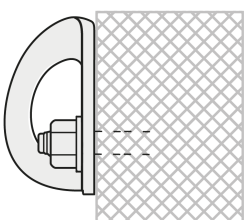
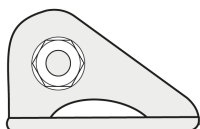

LAPPAS S.A.

5th Km Ioannina to Athens
IOANNINA, 45500
GREECE

 (+30) 26510 41 855

 www.lappasclimbing.com

 info@lappasclimbing.com

 [lappas climbing bolts](#)

Use Rhea Titan and Rock Anchor Titan only in case of compact rock (massif stone - granite). Don't use it on soft rock (sandstone e.t.c.)

Χρησιμοποιήστε το Rhea Titan και το Rock Anchor Titan μόνο σε περίπτωση συμπαγή βράχου (αβεστόλιθου ή γρανίτη).

Μην τα χρησιμοποιείτε σε μαλακό βράχο (αμμόλιθου κτλ.)