



Rock Anchor - Stainless Steel AISI 316L

Πλακέτα Ασφάλισης - Ανοξείδωτο Ατσάλι AISI 316L

user's manual / εγχειρίδιο χρήσης

certificates πιστοποιήσεις

EN 959:2018
EN 795:2012
EN 365:2004

suitable for κατάλληλο για

outdoor
 caving
 canyoning
 indoor
 rope access
 rescue

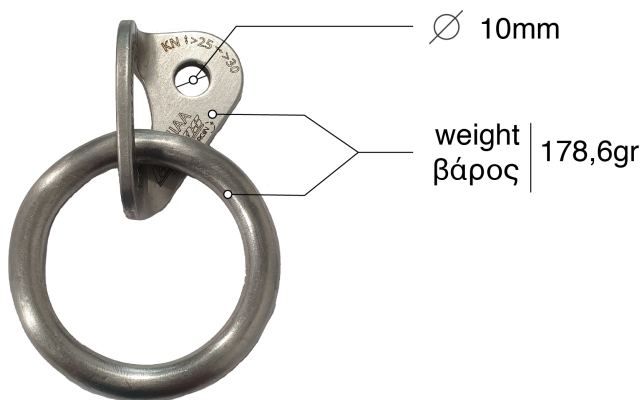

Serial number (10th week of 2020)
Σειριακός Αριθμός (10^η εβδομάδα του 2020)

Material: 316L
Υλικό: 316L

Strength / Φορτίο

International Climbing and Mountaineering Federation
Εθνική Ομοσπονδία Αναρρίχησης και Ορειβάστας

Model / Μοντέλο

Brand / Μάρκα

Class of the anchor: 2
Κλάση πλακέτας: 2

1P = Used by only one person at a time
1P = Χρησιμοποιείται από έναν άνθρωπο κάθε φορά

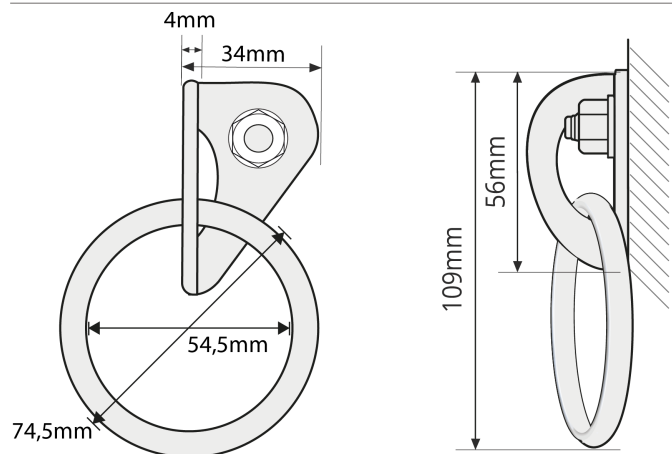

resistance requirements - statics tests
απαιτήσεις στατικής φόρτισης

A kN ←

A

EN 795:2012	12kN
EN 959:2018	15kN
UIAA 123 - 2	20kN

B

EN 795:2012	12kN
EN 959:2018	25kN
UIAA 123 - 2	25kN

B kN ↓

effective strenght / μέγιστη φόρτιση

A >30kN **B** >25kN

installation / τοποθέτηση

A

B

C

D

Wrench tool No 17
Torque = 30Nm

Κλειδί No 17
Ροπή = 30Nm

dynamic tests - effective strenght
δυναμική φόρτιση

EN 795:2012

load direction	peak of force (kN)	Deflection of anchor device (mm)	Displacement of anchor point (mm)
A	9,0	9,0	8,0
B	9,2	4,0	2,0



APPROVED USE / ΟΡΘΗ ΧΡΗΣΗ

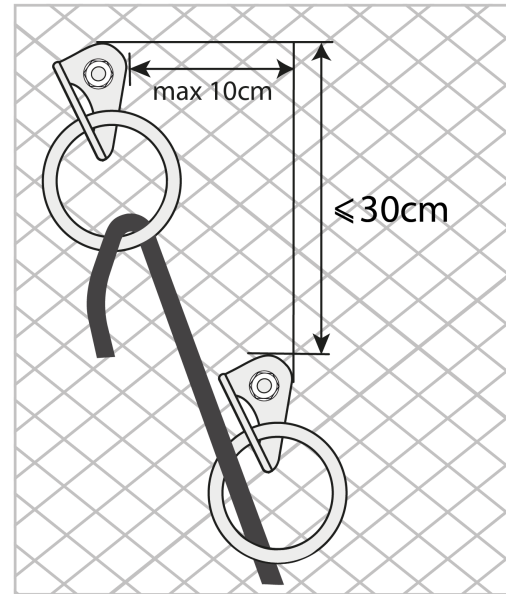
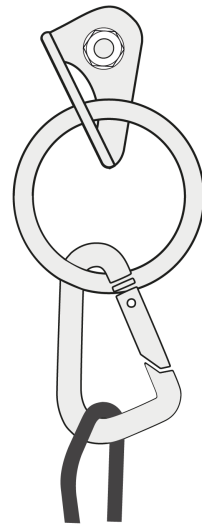
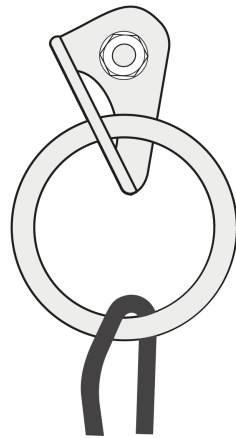
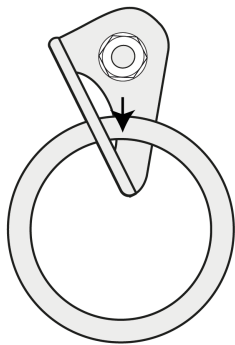

 rock / βράχος

 rope / σκοινί



WARNING : RISK OF ACCIDENT, INJURY OR DEATH

ΠΡΟΣΟΧΗ : ΚΙΝΔΥΝΟΣ ΑΤΥΧΗΜΑΤΟΣ, ΤΡΑΥΜΑΤΙΣΜΟΥ Ή ΘΑΝΑΤΟΥ

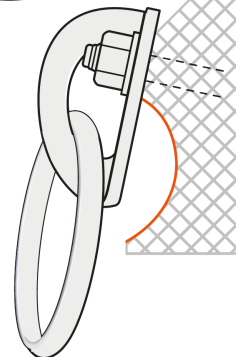
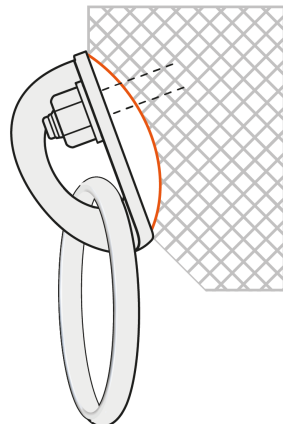
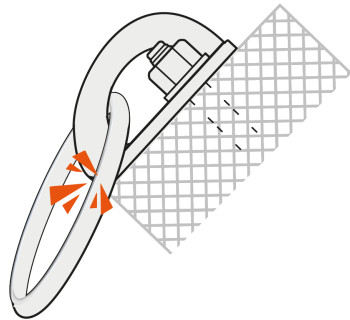
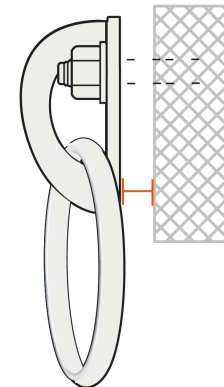
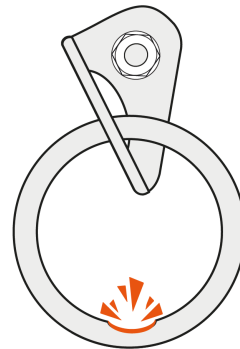
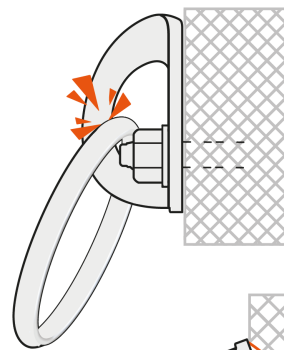
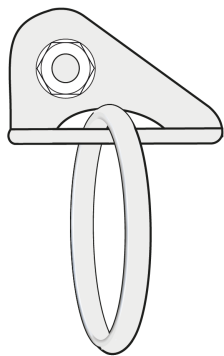

Use Sea Urchin + and rock anchor only in case of compact rock (massif stone - granite). Don't use it on soft rock (sandstone e.t.c.)

Χρησιμοποιήστε το Sea Urchin + και το βύσμα μόνο σε περίπτωση συμπαγή βράχου (ασβεστόλιθου ή γρανίτη).

Μην τα χρησιμοποιείτε σε μαλακό βράχο (αμμόλιθου κτλ.)

Lappas

climbing bolts

produced by climbers for climbers

LAPPAS S.A.

5Km Ioannina to Athens
Postal Code 45500
IOANNINA, GREECE

 (+30) 6932 423 007

 www.lappasclimbing.com

 info@lappasclimbing.com

  lappas climbing bolts