



Rock Anchor - Stainless Steel AISI 316L
Πλακέτα Ασφάλισης - Ανοξείδωτο Ατσάλι AISI 316L

user's manual / εγχειρίδιο χρήσης

certificates / πιστοποιήσεις
 EN 959:2018
 EN 795:2012
 EN 365:2004
UIAA

suitable for / κατάλληλο για

- outdoor
- caving
- canyoning
- indoor
- rope access
- rescue



Serial number (10th week of 2020)
 Σειριακός Αριθμός (10^η εβδομάδα του 2020)

Material: 316L
 Υλικό: 316L

Strength / Φορτίο

International Climbing and Mountaineering Federation
 Εθνική Ομοσπονδία Αναρρίχησης και Ορειβασίας

Model / Μοντέλο

Brand / Μάρκα

Class of the anchor: 2
 Κλάση πλακέτας: 2

1P = Used by only one person at a time
 1P = Χρησιμοποιείται από έναν άνθρωπο κάθε φορά

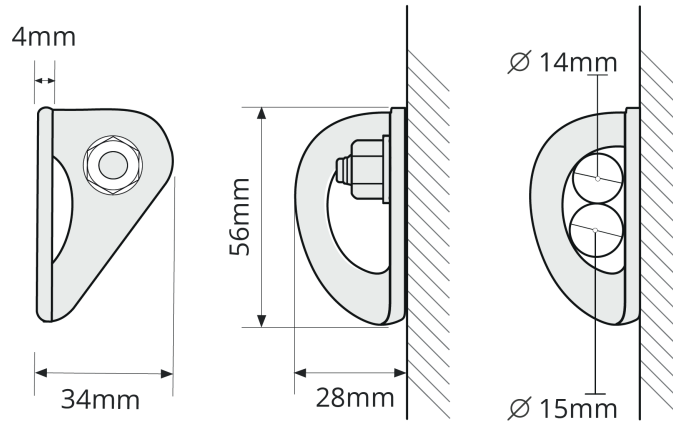

installation / τοποθέτηση

A

B

C

D

Wrench tool No 17
 Torque = 30Nm
 Κλειδί No 17
 Ροπή = 30Nm

resistance requirements - statics tests / απαιτήσεις στατικής φόρτισης

A	EN 795:2012	12kN
	EN 959:2018	15kN
	UIAA 123 - 2	20kN
B	EN 795:2012	12kN
	EN 959:2018	25kN
	UIAA 123 - 2	25kN

effective strenght / μέγιστη φόρτιση

A kN ←

B kN ↓

A >29kN **B** >30kN

dynamic tests - effective strenght / δυναμική φόρτιση



EN 795:2012

load direction	peak of force (kN)	Deflection of anchor device (mm)	Displacement of anchor point (mm)
A	9,0	9,0	8,0
B	9,2	4,0	2,0

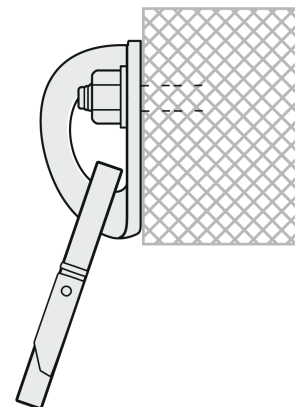
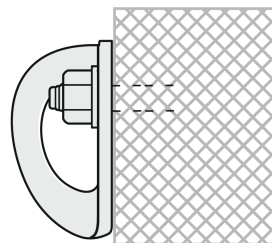
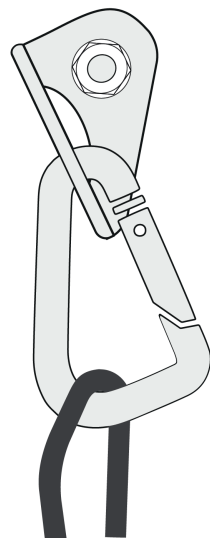
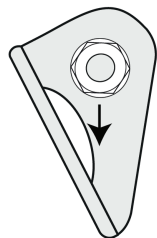

APPROVED USE / ΟΡΘΗ ΧΡΗΣΗ



 rock / βράχος
 rope / σκοινί



WARNING : RISK OF ACCIDENT, INJURY OR DEATH

ΠΡΟΣΟΧΗ : ΚΙΝΔΥΝΟΣ ΑΤΥΧΗΜΑΤΟΣ, ΤΡΑΥΜΑΤΙΣΜΟΥ Ή ΘΑΝΑΤΟΥ

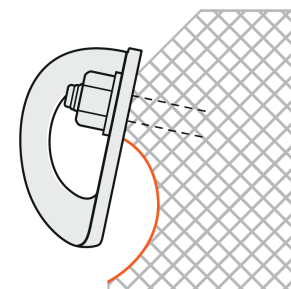
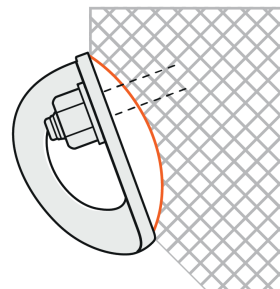
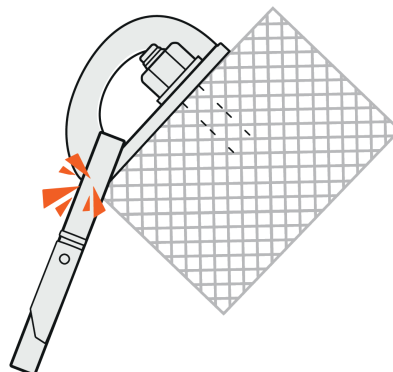
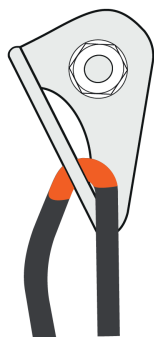
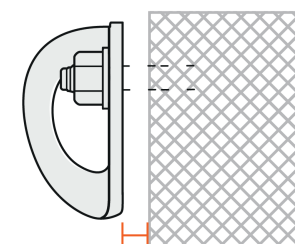
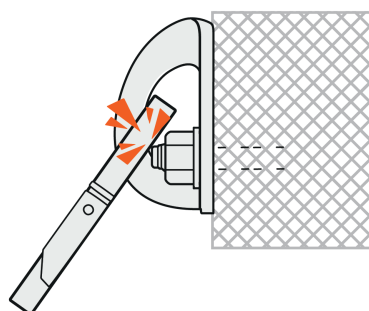
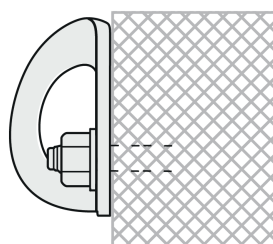
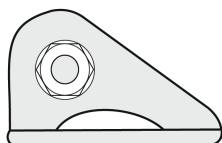

Use Sea Urchin and rock anchor only in case of compact rock (massif stone - granite). Don't use it on soft rock (sandstone e.t.c.)

Χρησιμοποιήστε το Sea Urchin και το βύσμα μόνο σε περίπτωση συμπαγή βράχου (αβεστόλιθου ή γρανίτη).
Μην τα χρησιμοποιείτε σε μαλακό βράχο (αμμόλιθου κτλ.)

Lappas

climbing bolts

produced by climbers for climbers

LAPPAS S.A.

5Km Ioannina to Athens
Postal Code 45500
IOANNINA, GREECE

 (+30) 6932 423 007

 www.lappasclimbing.com

 info@lappasclimbing.com

  [lappas climbing bolts](https://www.facebook.com/lappasclimbingbolts)