



**Rock Anchor - Stainless Steel AISI 316L**

Πλακέτα Ασφάλισης - Ανοξείδωτο Ατσάλι AISI 316L

user's manual / εγχειρίδιο χρήσης

certificates πιστοποιήσεις

EN 959:2018  
EN 795:2012  
EN 365:2004

UIAA

suitable for κατάλληλο για

indoor outdoor  
rope access caving  
rescue canyoning



Serial number (10th week of 2020)  
Σειριακός Αριθμός (10<sup>η</sup> εβδομάδα του 2020)

Material: 316L  
Υλικό: 316L

Strength / Φορτίο

International Climbing and Mountaineering Federation  
Εθνική Ομοσπονδία Αναρρίχησης και Ορειβασίας

Model / Μοντέλο

Brand / Μάρκα

Class of the anchor: 2  
Κλάση πλακέτας: 2

1P = Used by only one person at a time  
1P = Χρησιμοποιείται από έναν άνθρωπο κάθε φορά

Tested according to the standard indicated  
Ελεγμένο σύμφωνα με τα αναγραφόμενα πρότυπα

Read instructions before use  
Διαβάστε τις οδηγίες πριν την χρήση

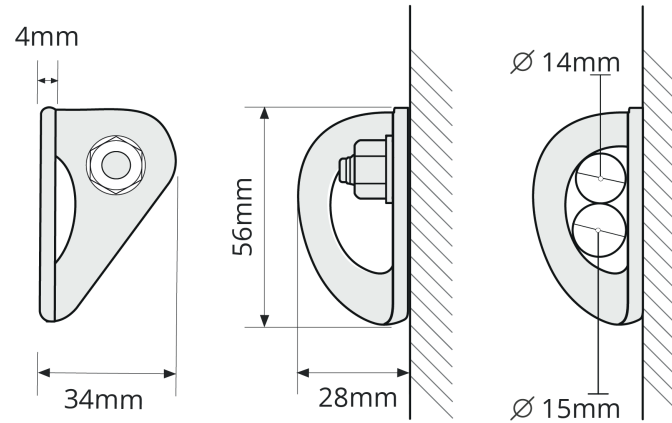

installation / τοποθέτηση

A

B

C

D

∅ 12mm

Wrench tool No 19  
Torque = 50Nm

Κλειδί No 19  
Ροπή = 50Nm

resistance requirements - statics tests  
απαιτήσεις στατικής φόρτισης

A	EN 795:2012	12kN
	EN 959:2018	15kN
	UIAA 123 - 2	20kN
B	EN 795:2012	12kN
	EN 959:2018	25kN
	UIAA 123 - 2	25kN

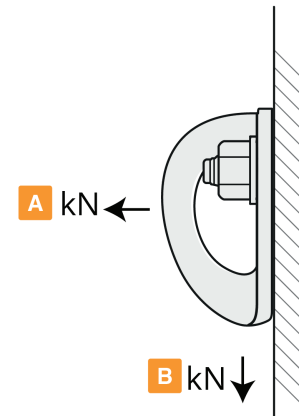

effective strenght / μέγιστη φόρτιση

A >29kN B >30kN

dynamic tests - effective strenght  
δυναμική φόρτιση

EN 795:2012

load direction	peak of force (kN)	Deflection of anchor device (mm)	Displacement of anchor point (mm)
A	9,4	13	11
B	9,4	8	6



## APPROVED USE / ΟΡΘΗ ΧΡΗΣΗ

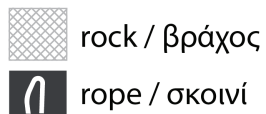
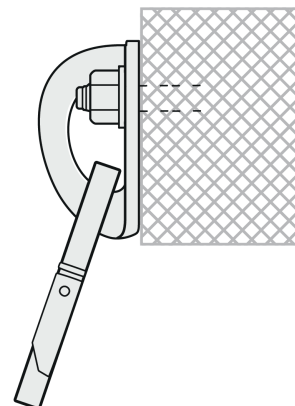
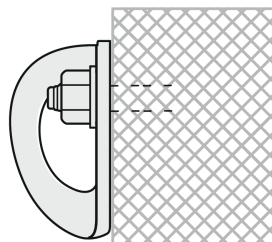
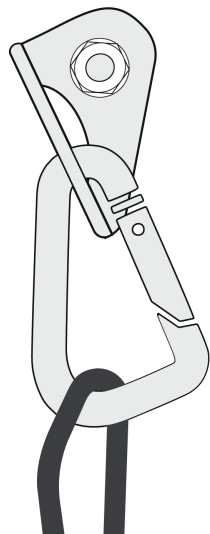
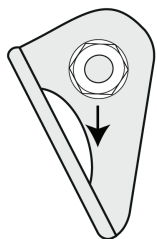

rock / βράχος

rope / σκοινί



**WARNING : RISK OF ACCIDENT, INJURY OR DEATH**

**ΠΡΟΣΟΧΗ : ΚΙΝΔΥΝΟΣ ΑΤΥΧΗΜΑΤΟΣ, ΤΡΑΥΜΑΤΙΣΜΟΥ Ή ΘΑΝΑΤΟΥ**

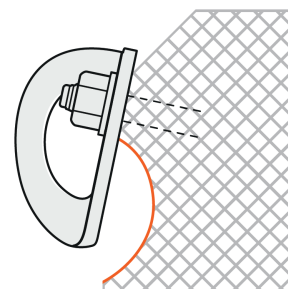
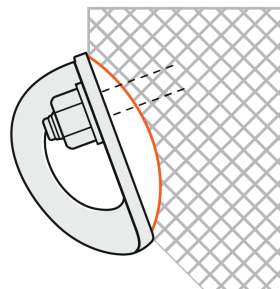
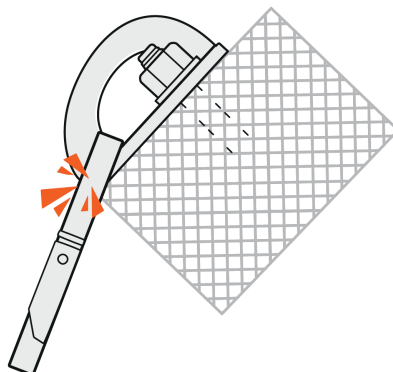
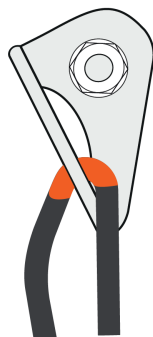
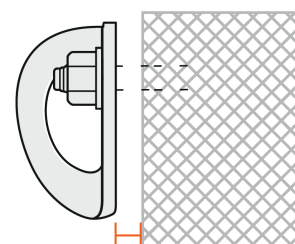
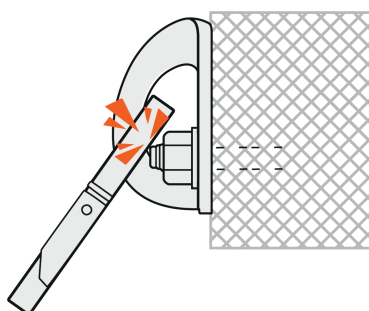
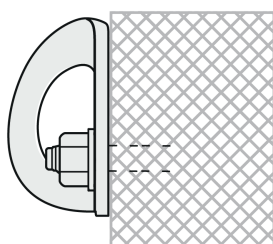
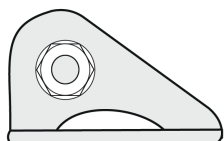

Use Sea Urchin and rock anchor only in case of compact rock (massif stone - granite). Don't use it on soft rock (sandstone e.t.c.)

Χρησιμοποιήστε το Sea Urchin και το βύσμα μόνο σε περίπτωση συμπαγή βράχου (αβεστόλιθου ή γρανίτη).

Μην τα χρησιμοποιείτε σε μαλακό βράχο (αμμόλιθου κτλ.)

# **Lappas**

climbing bolts

produced by climbers for climbers

LAPPAS S.A.

5Km Ioannina to Athens

Postal Code 45500

IOANNINA, GREECE

(+30) 6932 423 007

www.lappasclimbing.com

info@lappasclimbing.com

lappas climbing bolts