



1/2" SEA URCHIN

Rock Anchor - Stainless Steel AISI 316L
Πλακέτα Ασφάλισης - Ανοξείδωτο Ατσάλι AISI 316L

user's manual / εγχειρίδιο χρήσης

certificates
πιστοποιήσεις
EN 959:2018
EN 795:2012
EN 365:2004
UIAA

suitable for
κατάλληλο για
indoor
outdoor
rope access
caving
rescue
canioning



∅ 1/2"

weight / βάρος
52,4g

Serial number (10th week of 2020)
Σειριακός Αριθμός (10^η εβδομάδα του 2020)

Material: 316L
Υλικό: 316L

Strength / Φορτίο

International Climbing and Mountaineering Federation
Εθνική Ομοσπονδία Αναρρίχησης και Ορειβασίας

Model / Μοντέλο

Brand / Μάρκα

Class of the anchor: 2
Κλάση πλακέτας: 2

1P = Used by only one person at a time
1P = Χρησιμοποιείται από έναν άνθρωπο κάθε φορά

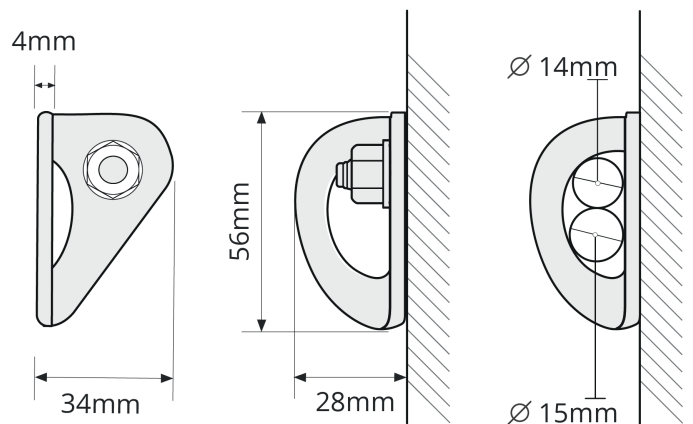

installation / τοποθέτηση

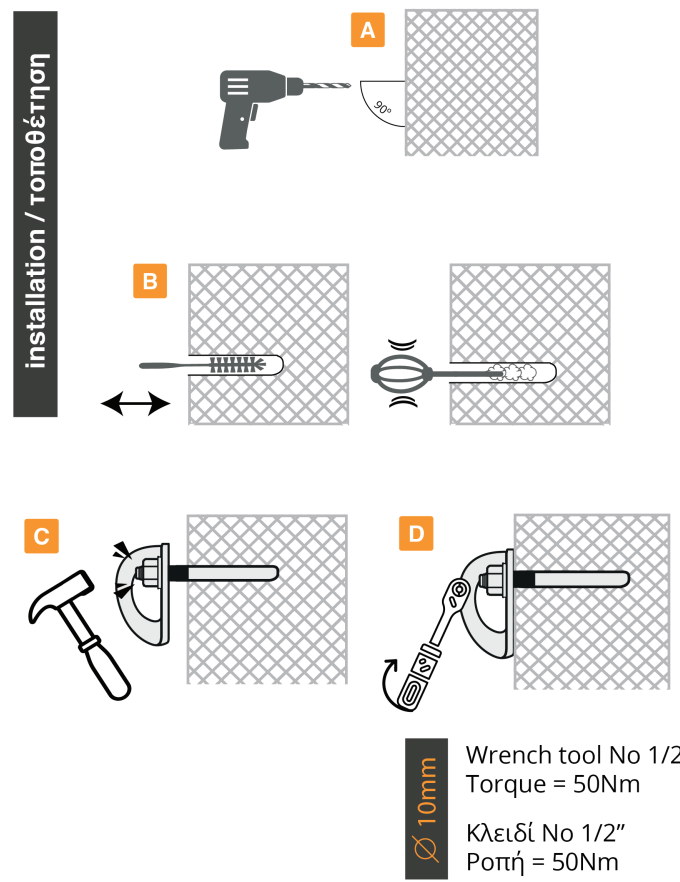

resistance requirements - statics tests
απαιτήσεις στατικής φόρτισης

A	EN 795:2012	12kN
	EN 959:2018	15kN
	UIAA 123 - 2	20kN
B	EN 795:2012	12kN
	EN 959:2018	25kN
	UIAA 123 - 2	25kN

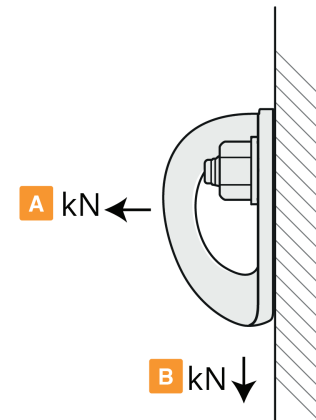

effective strenght / μέγιστη φόρτιση

A >29kN B >30kN

dynamic tests - effective strength
δυναμική φόρτιση



EN 795:2012

load direction	peak of force (kN)	Deflection of anchor device (mm)	Displacement of anchor point (mm)
A	9,4	13	11
B	9,4	8	6

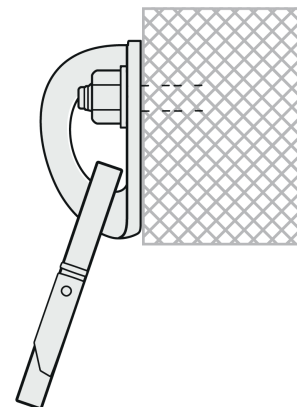
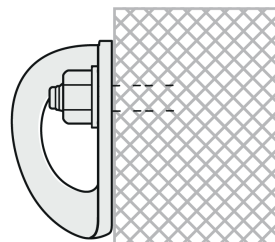
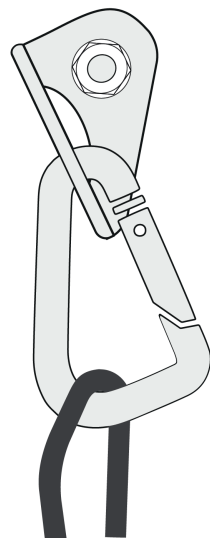
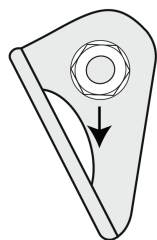

APPROVED USE / ΟΡΘΗ ΧΡΗΣΗ



 rock / βράχος
 rope / σκοινί



WARNING : RISK OF ACCIDENT, INJURY OR DEATH

ΠΡΟΣΟΧΗ : ΚΙΝΔΥΝΟΣ ΑΤΥΧΗΜΑΤΟΣ, ΤΡΑΥΜΑΤΙΣΜΟΥ Ή ΘΑΝΑΤΟΥ

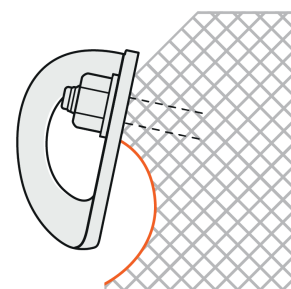
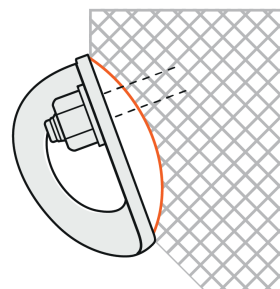
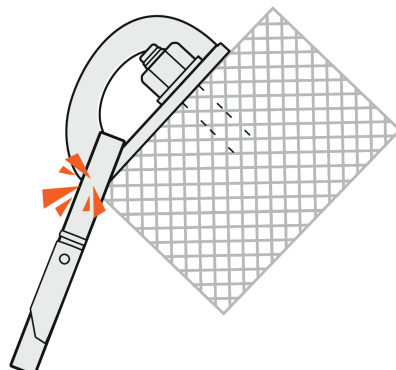
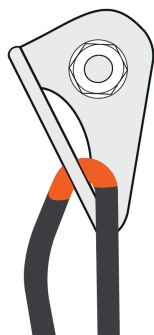
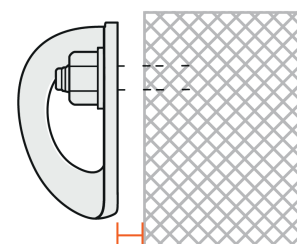
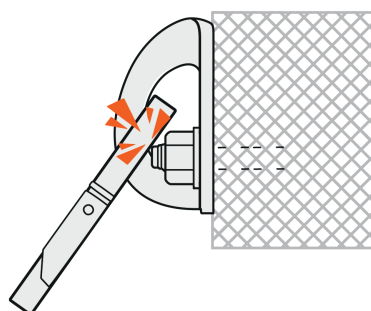
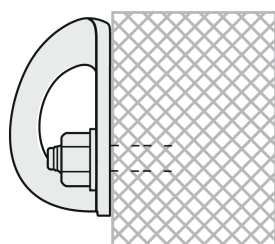
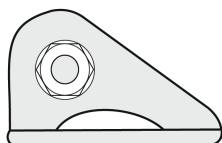

Lappas

climbing.com

produced by climbers for climbers

LAPPAS S.A.

5Km Ioannina to Athens
Postal Code 45500
IOANNINA, GREECE

 (+30) 6932 423 007

 www.lappasclimbing.com

 info@lappasclimbing.com

  lappas climbing bolts

Use Sea Urchin and rock anchor only in case of compact rock (massif stone - granite). Don't use it on soft rock (sandstone e.t.c.)

Χρησιμοποιήστε το Sea Urchin και το βύσμα μόνο σε περίπτωση συμπαγή βράχου (αβεστόλιθου ή γρανίτη).

Μην τα χρησιμοποιείτε σε μαλακό βράχο (αμμόλιθου κτλ.)