



Rock Anchor - Stainless Steel AISI 316L (Marine)  
Πλακέτα Ασφάλισης - Ανοξείδωτο Ατσάλι AISI 316L (Marine)

user's manual / εγχειρίδιο χρήσης

certificates πιστοποιήσεις	EN 959:2018	suitable for κατάλληλο για	outdoor	caving
	EN 365:2004		rescue	canyoning
UIAA				



Serial number (10th week of 2020) Σειριακός Αριθμός (10 <sup>η</sup> εβδομάδα του 2020)	Material: 316L / Υλικό: 316L	Marine Version
Tested according to the standard indicated Ελεγμένο σύμφωνα με τα αναγραφόμενα πρότυπα	Strength / Φορτίο	International Climbing and Mountaineering Federation Εθνική Ομοσπονδία Αναρρίχησης και Ορειβάσις
Read instructions before use Διαβάστε τις οδηγίες πριν την χρήση	Model / Μοντέλο	Brand / Μάρκα
Class of the anchor: 2 Κλάση πλακέτας: 2	1P = Used by only one person at a time 1P = Χρησιμοποιείται από έναν άνθρωπο κάθε φορά	

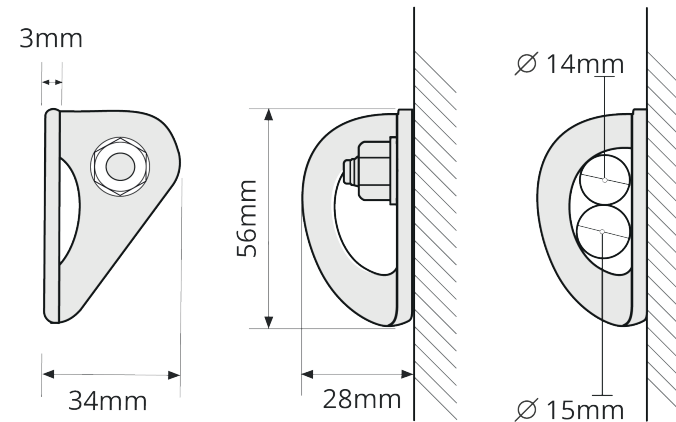

**resistance requirements - statics tests**  
**απαιτήσεις στατικής φόρτισης**

<b>A</b>	EN 959:2018 15kN UIAA 123 - 2 20kN	<b>A</b> kN ←
<b>B</b>	EN 959:2018 25kN UIAA 123 - 2 25kN	<b>B</b> kN ↓

**effective strenght / μέγιστη φόρτιση**

**A** >20kN    **B** >25kN

**installation / τοποθέτηση**

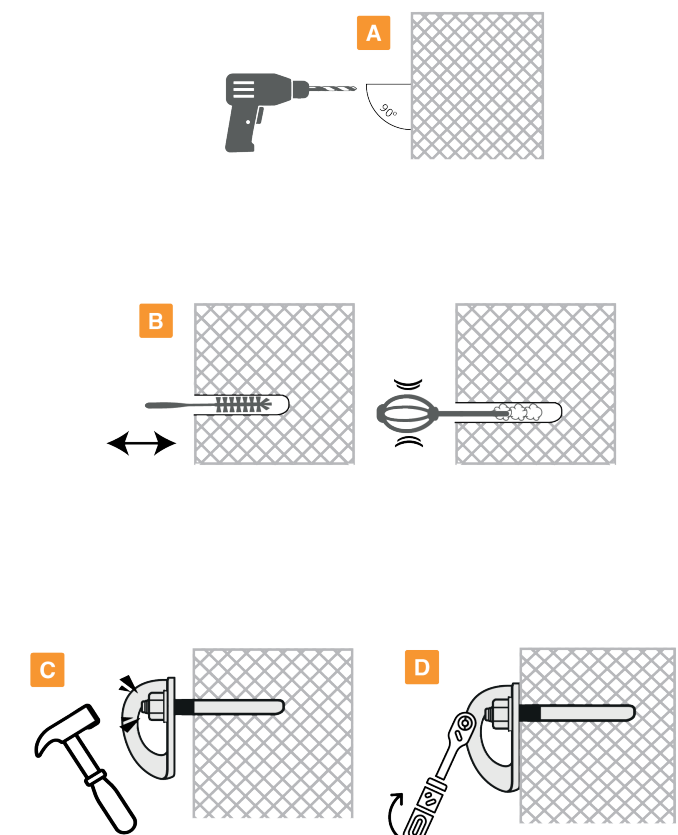

Check the exposed part of the hang fix.  
The nut has to be totally screwed on the hang fix but the hang fix has not to come out during installation.  
In this way you can check the correct depth of installation.

<b>10mm</b>	Wrench tool No 17 Torque = 30Nm	<b>12mm</b>	Wrench tool No 19 Torque = 50Nm
	Κλειδί No 17 Ροπή = 30Nm		Κλειδί No 19 Ροπή = 50Nm



APPROVED USE / ΟΡΘΗ ΧΡΗΣΗ

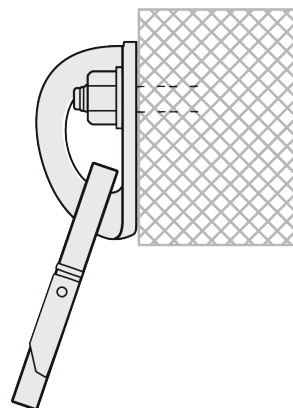
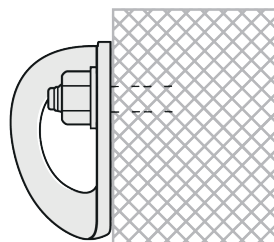
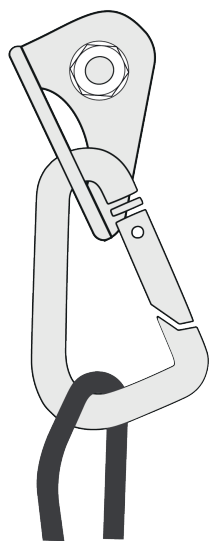
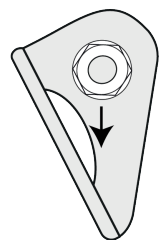

rock / βράχος  
rope / σκοινί



WARNING : RISK OF ACCIDENT, INJURY OR DEATH

ΠΡΟΣΟΧΗ : ΚΙΝΔΥΝΟΣ ΑΤΥΧΗΜΑΤΟΣ, ΤΡΑΥΜΑΤΙΣΜΟΥ Ή ΘΑΝΑΤΟΥ

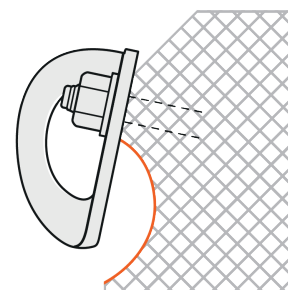
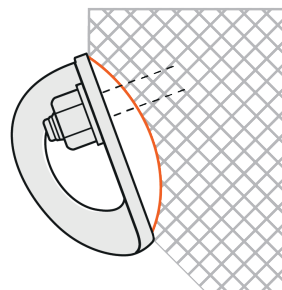
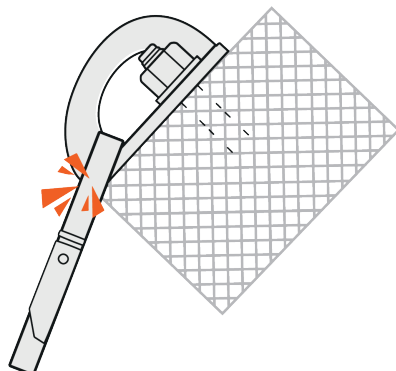
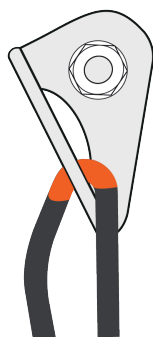
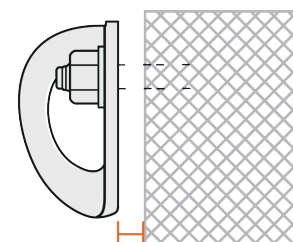
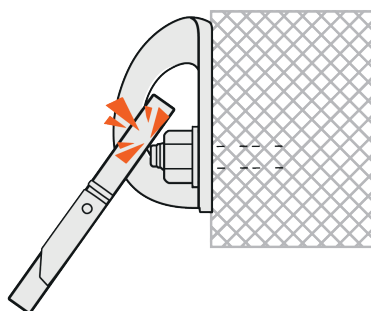
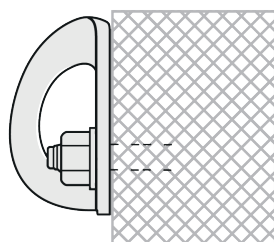
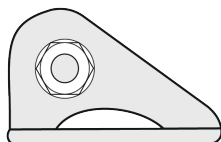

Use Alpine and rock anchor only in case of compact rock (massif stone - granite). Don't use it on soft rock (sandstone e.t.c.)

Χρησιμοποιήστε το Sea Urchin και το βύσμα μόνο σε περίπτωση συμπαγή βράχου (ασβεστόλιθου ή γρανίτη).  
Μην τα χρησιμοποιείτε σε μαλακό βράχο (αμμόλιθου κτλ.)

**Lappas**  
climbing bolts

LAPPAS S.A.

5th Km nat.rd Ioannina - Athens  
IOANNINA, 45500  
GREECE

(+30) 26510 41 855

www.lappasclimbing.com

info@lappasclimbing.com

lappas climbing bolts